

Model 260-11R

1/2" Standard Pipe Thread

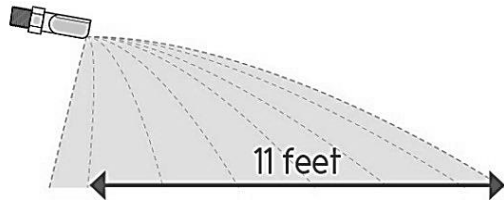

Spray Distance	Effective Distance	Mounting Angle	PSI	GPM	Speed (Miles Per Hour)								
					2	4	5	6	8	10	12	14	15
11 ft	11 ft	DOWN	30	6.8	153	77	61	51	38	31	26	22	20
11 ft	11 ft	DOWN	40	8	180	90	72	60	45	36	30	26	24
11 ft	11 ft	DOWN	50	8.8	198	99	79	66	50	40	33	28	26

Shaded area represents gallons per acre.

Other Models Available for Agricultural and Roadside/Right-of-Way Applications:

Standard Band

Model	NPT	PSI Range	Distance (feet)	Speed Range (MPH)	Output (GPM)	Gallons/Acre
125/125R	1/4"	30 - 40	17	1 - 7	1.7 - 2.0	7.8 - 64
140/140R	1/4"	30 - 50	18	2 - 15	2.0 - 2.7	4.0 - 41
187/187R	3/8"	30 - 50	20	2 - 15	3.6 - 4.8	6.4 - 64
265/265R	1/2"	30 - 50	21	2 - 15	6.8 - 8.8	11 - 112
375/375R	3/4"	30 - 50	23	2 - 15	14.4 - 18.8	22 - 216
437/437R	3/4"	30 - 50	31	2 - 15	18.5 - 24.2	21 - 203
500/500R	1"	30 - 50	21.5	4 - 30	29 - 37	24 - 229
504/504R	1"	30 - 50	41	2 - 15	29 - 37	24 - 229

Narrow Band

Model	NPT	PSI Range	Distance (feet)	Speed Range (MPH)	Output (GPM)	Gallons/Acre
120-3/120-3R	1/4"	30 - 50	3	2 - 15	1.7 - 2.2	19 - 181
120-5/120-5R	1/4"	30 - 50	5	2 - 15	1.7 - 2.2	11 - 109
180-6/180-6R	3/8"	30 - 50	6	2 - 15	3.6 - 4.8	20 - 198
180-10/180-10R	3/8"	30 - 50	10	2 - 15	3.6 - 4.8	12 - 109
260-5/260-5R	1/2"	30 - 50	5	2 - 15	6.8 - 8.8	45 - 435
260-11-260-11R	1/2"	30 - 50	11	2 - 15	6.8 - 8.8	20 - 198
370/370R	3/4"	30 - 50	10	2 - 15	6.8 - 8.8	24 - 233

Nozzle Installation & Operation – Roadside/Right of Way Applications

- The supply line from the pump should be one pipe size larger than the nozzle thread size. For example, if the nozzle has a 1/2" thread, the supply line should be 3/4".
- Boom Buster nozzles are tested at a height of 48' above ground level. They can be mounted lower or higher than 48'. This may require adjusting the angle of the nozzle to achieve the correct distance (in feet) as specified in the nozzle selection guide.
- Some Boom Buster nozzles are designed to be mounted level, while others should be angled either up or down.
- Mounting nozzles on street elbows allows for quick and easy nozzle adjustment. Example mounting options and adjustments are illustrated below.

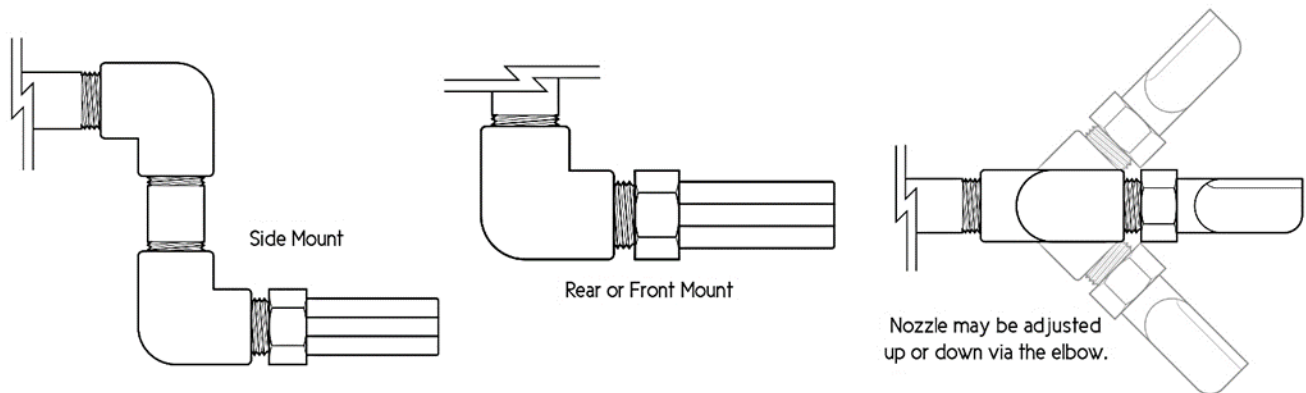

- In some applications, except for the small nozzles, these nozzles may be operated at speeds up to thirty miles per hour.
- While small mesh nozzle strainers are not necessary, a coarse mesh inline strainer may be necessary if tank or water supply becomes contaminated with large particles.
- Minimize drift by spraying just above the ground to be sprayed. As with any method of spraying, high or gusty wind can cause some pattern shifting. Always use good judgment when spraying; do not spray in high winds.
- Spray it safe! Always wear protective clothing and handle all chemicals with care.

